

Your new electronic thermostat is equipped with a microprocessor with proportional integral adaptive (PIA) temperature control technology for total comfort.

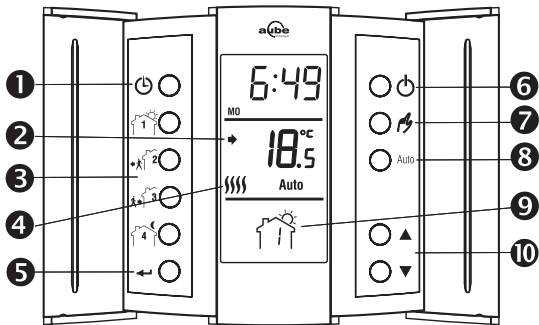

- | | | |
|--|------------------|-----------------------|
| 1 Clock/Day settings | 4 Heating is On | 8 Auto mode |
| 2 Setpoint is displayed when arrow appears | 5 Return/Exit | 9 Current program |
| 3 Program settings | 6 Power (On/Off) | 10 Adjustment buttons |
| | 7 Manual mode | |

1 Installation & Wiring

1.1 Guidelines

Turn off power to the heating system at the main power panel to avoid electrical shock. The installation must be performed by an electrician.

- ▶ High voltage thermostats must be installed onto an electrical box.
- ▶ For a new installation, choose a location about 1.5 metres above the floor.
- ▶ The thermostat must be installed facing the heating system.
- ▶ The thermostat must be installed on an inside wall.
- ▶ Avoid locations where there are air drafts (top of staircase, air outlet), dead air spots (behind a door), direct sunlight or concealed chimneys or stove pipes.

1.2 Installation Procedure

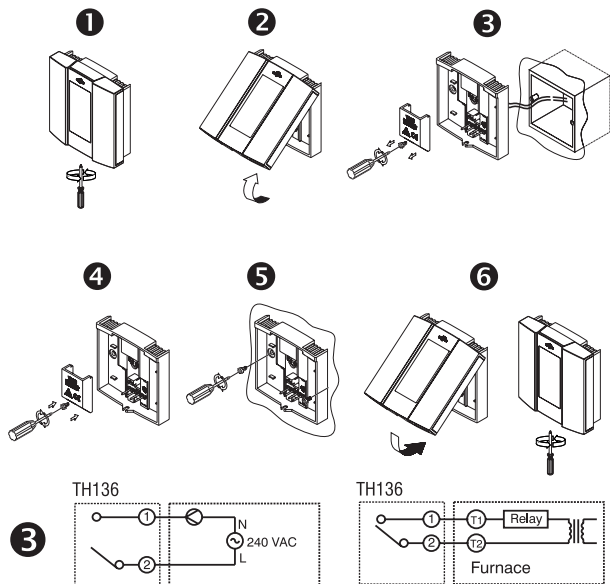

- Remove the screw holding the control module to the power base.

NOTE: Please note that the screw cannot be completely removed.

- Lift the control module to remove it from the power base.
- On the power base, remove the screw holding the wire cover and wire the thermostat.

NOTE: The terminals are designed for wires of cross-section measuring 0.33 to 2.5 mm².

- Once all wiring is complete, secure wire cover.
- Secure the power base onto the electrical box using the mounting holes.
- Mount the control module onto the power base and secure using the screw.
- Return power to the heating system.

NOTE: Keep the thermostat's air vents clean and free from obstructions.

2 Remote Input Wiring

The TH136 is equipped with a remote input which allows connection of a telephone controller (optional CT240) or a home automation system. When a signal is received through this input, the TH136 will automatically switch from normal operating mode to Frost Protection mode, or vice versa.

NOTE: For details on operating the telephone controller, see *Operating Modes*.

2.1 Connection to the CT240

Connect CT240 terminals A and C to TH136 terminals X and C respectively. You must respect the polarity.

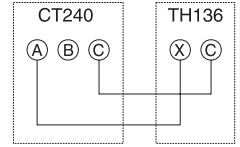

2.2 Connection to a home automation system

Connect the TH136 to the home automation system as displayed in the wiring diagram.

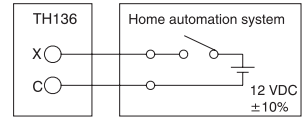

3 Installing the Batteries

When you first install the batteries, the unit runs a sequence of tests which lasts approximately 5 seconds. After the tests, the screen should display the current temperature.

NOTE: We recommend replacing the batteries at least once a year.

The TH136 will display an icon indicating that the batteries must be replaced. This icon will be displayed for 60 days; after this delay, the TH136 will shut down the heating unit. Once batteries have been replaced, you will have to reprogram the clock & day settings; all other programming is stored in a protected memory.

On/Off Button

The thermostat is equipped with an On/Off button making it possible to put the thermostat in sleep mode when its use is not required (e.g. summer). This will not affect the clock or programming.

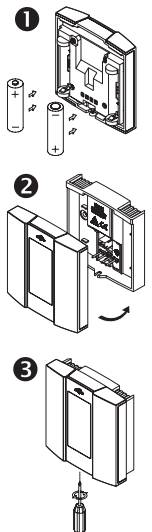

4 Clock and Day Settings

- Press ; the hour segment flashes.
- Press to set the hour.
- Press ; the minutes segment flashes.
- Press to set the minutes.
- Press ; the day flashes.
- Press to set the day.
- Press to exit.

5 Operating Modes

5.1 Automatic

Executes the schedule. Press **Auto** to activate the Auto mode.

5.2 Manual

Maintains a constant temperature. Press to activate the Manual mode and set the temperature using .

5.3 Frost Protection

Maintains the Frost Protection setpoint during a prolonged absence. The Frost Protection setpoint is pre-programmed to 10°C. To modify, see *Advanced Programming*. There are 2 ways to activate the Frost Protection mode:

- From the thermostat:
Press for 1 second to activate the Manual mode. Hold for 3 seconds. The icon is displayed. To deactivate the Frost Protection mode, activate the Auto or Manual mode.
- From a telephone (remote location) when the TH136 is connected to a CT240 telephone controller.

NOTE: For details on how to activate the Frost Protection mode using a telephone, refer to the *CT240 Instruction Manual*.

WARNING: When the Frost Protection mode is activated remotely, it must be deactivated remotely.

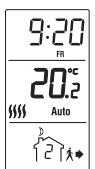

Automatic



Manual

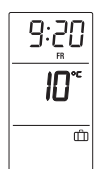

Frost Protection

5.4 Temporary Bypass

When the TH136 is in Auto or Frost Protection mode, you can bypass the mode for two (2) hours. The TH136 will maintain the temperature bypass for two (2) hours, then return to previous operating mode. Set the temperature using these buttons ▲▼. The icon corresponding to the bypassed mode will flash to indicate the bypass.

6 Pre-programmed Schedule

The TH136 programmable thermostat is pre-programmed with the following schedule:

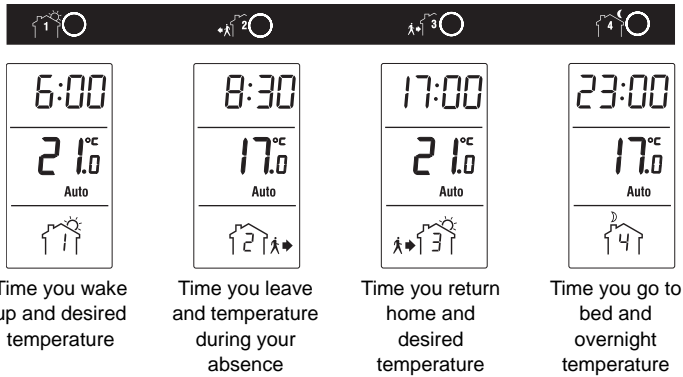

Programs 1 and 4 are repeated from Monday to Sunday.

Programs 2 and 3 are repeated from Monday to Friday.

7 Modify the Schedule

To modify the pre-programmed schedule, follow these steps:

- 1 Press the button associated with the program you wish to modify.

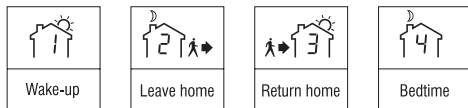

- 2 Enter the program start time using the ▲▼ buttons.
- 3 Press the program button again.
- 4 Enter the desired temperature using the ▲▼ buttons.
- 5 Press ← to exit.

NOTE: After 60 seconds of inactivity, the thermostat will automatically exit programming mode.

The TH136 thermostat is equipped with the Early Start function (deactivated by default). To activate, refer to Advanced Programming.

8 Advanced Programming

You must hold the Auto button for 3 seconds to access the advanced programming. Then, press Auto to select a menu.

Menus	Default	Options
PPd MO	4	0, 2, 4
PPd TU	4	0, 2, 4
PPd WE	4	0, 2, 4
PPd TH	4	0, 2, 4
PPd FR	4	0, 2, 4
PPd SA	2	0, 2, 4
PPd SU	2	0, 2, 4
CPH	5	2, 3, 4, 5, 6
HLd	10°C	5°C to 28°C
ES	OF (off)	OF / ON
PP	OF (off)	OF / ON

- 1 Press Auto until the desired menu is displayed.
- 2 To modify the default programming, use the ▲▼ buttons and select from the available options.
- 3 Press ← to exit.

NOTE: Menus are detailed below.

8.1 Modify the Number of Programs per Day (PPd)

You can select the number of programs to be executed for each day of the week. This means, you can run all 4 programs, only 2 (1st and 4th) or none (0).

NOTE: When none (0) is selected, the TH136 will maintain the temperature setpoint of the last program.

8.2 Modify the Heating Cycles (CPH)

For greater flexibility, you can define the cycle that best suits your requirements. The shorter the cycles, the greater your comfort. However, your system will be activated more often when using shorter cycles.

Cycles/hour	Length	Installation
2	30 min.	Commercial unit
3	20 min.	Commercial unit
4	15 min.	Fuel, gas & electrical furnace
5	12 min.	Direct wiring to circulator
6	10 min.	Direct wiring to circulator

8.3 Modify the Frost Protection Setpoint (HLd)

Use this menu to modify the Frost Protection setpoint associated with the Frost Protection mode. The setting range is between 5°C and 28°C. Default: 10°C.

8.4 Early Start (ES)

When Early Start is activated, the TH136 calculates the optimum start time to obtain the desired temperature by the programmed set time.

8.5 Pump Protection (PP)

For hot water installations, it is recommended that the pump be activated at least 15 seconds every 24 hours to avoid any seizing.

9 Technical Specifications

Power supply: 2 AAA (LR03) alkaline batteries

Max. resistive load: 5A @ 240 VAC

Max. inductive load: 2A @ 240 VAC

Remote input: 12 VDC / ± 10% / 5 mA

Control device: Electronic

Automatic action: Type 1B

Storage temperature: -20°C to 50°C

Operating temperature: 0°C to 50°C, 95% relative humidity without condensation

Temperature setpoint range: 5°C to 28°C

Temperature setpoint interval: 0.5°C

Temperature display resolution: 0.1°C

Temperature display accuracy: ± 0.3°C

Software: Class A

Protection degree: IP 20

Environment: normally polluted

Warranty

Aube warrants this product, excluding battery (if applicable), to be free from defects in the workmanship or materials, under normal use and service, for a period of three (3) years from the date of purchase by the consumer. If at any time during the warranty period the product is determined to be defective or malfunctions, Aube shall repair or replace it (at Aube's option).

If the product is defective,

- (i) return it, with a bill of sale or other dated proof of purchase, to the place from which you purchased it, or
- (ii) contact Aube. Aube will make the determination whether the product should be returned, or whether a replacement product can be sent to you.

This warranty does not cover removal or reinstallation costs. This warranty shall not apply if it is shown by Aube that the defect or malfunction was caused by damage which occurred while the product was in the possession of a consumer.

Aube's sole responsibility shall be to repair or replace the product within the terms stated above. AUBE SHALL NOT BE LIABLE FOR ANY LOSS OR DAMAGE OF ANY KIND, INCLUDING ANY INCIDENTAL OR CONSEQUENTIAL DAMAGES RESULTING, DIRECTLY OR INDIRECTLY, FROM ANY BREACH OF ANY WARRANTY, EXPRESS OR IMPLIED, OR ANY OTHER FAILURE OF THIS PRODUCT. Some provinces and states do not allow the exclusion or limitation of incidental or consequential damages, so this limitation may not apply to you.

THIS WARRANTY IS THE ONLY EXPRESS WARRANTY AUBE MAKES ON THIS PRODUCT. THE DURATION OF ANY IMPLIED WARRANTIES, INCLUDING THE WARRANTIES OF MERCHANTABILITY AND FITNESS FOR A PARTICULAR PURPOSE, IS HEREBY LIMITED TO THE THREE-YEAR DURATION OF THIS WARRANTY. Some provinces and states do not allow limitations on how long an implied warranty lasts, so the above limitation may not apply to you.

This warranty gives you specific legal rights, and you may have other rights which vary from province or state to another.

Technical Assistance



705 Montrichard
Saint-Jean-sur-Richelieu
Québec, Canada J2X 5K8
Tel. : (450) 358-4600
1-800-831-AUBE
Fax : (450) 358-4650
aube.service@honeywell.com



10 rue Ampère
95500 Gonesse
France
33 (0) 1 34 07 99 00
33 (0) 1 34 07 99 19
advaupe@comintes.com

For more information on our products, visit us at

www.aubetech.com